

1988-98 GM-C/K SERIES WIRING SCHEMATIC

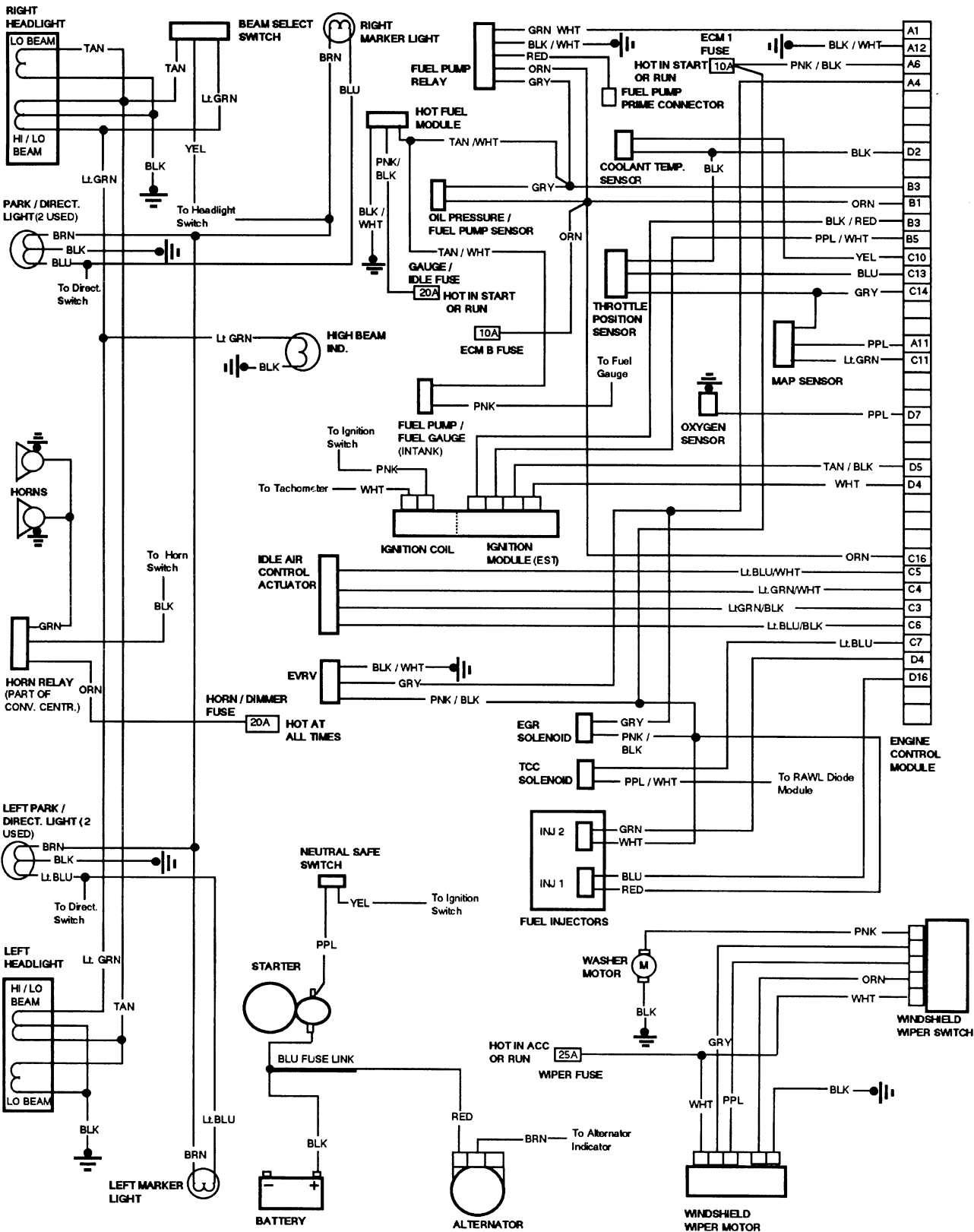

DIAGRAM 3